

Water Specialist

1" Control Valve Series Model: WS1

1.25" Control Valve Series Model: WS1.25

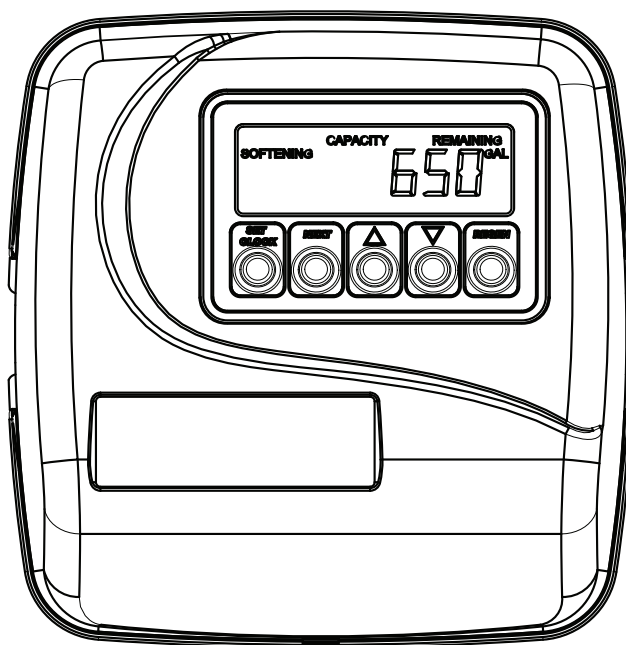

Operation and Instruction Manual for OEM Only.

Please Note: This operation and instruction manual is for the training of the OEM and for the OEM to use to train their customers. This document is not to be used as the complete system manual.

Table of Contents

Control Valve Function and Cycles of Operation	4
OEM General Programming Instructions	8
OEM Softener System Setup	9
OEM Filter System Setup	11
Installer Displays/Settings	12
User Displays/Settings	12
Diagnostics	14
Valve History	15
Drawings and Part Numbers	
Front Cover and Drive Assembly	16

**FOR INFORMATION COMMON TO ALL 1" & 1.25" CONTROL VALVES REFER TO THE
WS1 & WS1.25 DRAWINGS AND SERVICE MANUAL**

Control Valve Function and Cycles of Operation

This glass filled Noryl¹ (or equivalent) fully automatic control valve is designed as the primary control center to direct and regulate all cycles of a water softener or filter. When the WS1 or the WS1.25 control valve is manufactured as a softener, the control valve can be ordered to perform downflow or upflow regeneration. When the WS1 or WS1.25 control valve is set up as a filter, the control valve can be set to perform downflow regeneration or simply backwash. The control valve can be set to regenerate on demand (consumption of a predetermined amount of water) and/or as a time clock (passage of a particular number of days). The control valve can be set so that a softener can meet the Water Quality Association (WQA) Standard S100 or NSF/ANSI Standard 44 efficiency rating.

It is not recommended to change control valves from downflow to upflow brining or vice versa in the field. The valve bodies for downflow and upflow are unique to the regeneration type and should not be interchanged. A mismatch of valve body and regeneration piston will result in hard water bypass during service.

The control valve is compatible with a variety of regenerants and resin cleaners. The control valve is capable of routing the flow of water in the necessary paths to regenerate or backwash water treatment systems. The injector regulates the flow of brine or other regenerants. The control valve regulates the flow rates for backwashing, rinsing, and the replenishing of treated water into a regenerant tank, when applicable.

The control valve uses no traditional fasteners (e.g. screws); instead clips, threaded caps and nuts and snap type latches are used. Caps and nuts only need to be firmly hand tightened because radial seals are used. Tools required to service the valve include one small blade screw driver, one large blade screw driver, pliers and a pair of hands. A plastic wrench is available which eliminates the need for screwdrivers and pliers. Disassembly for servicing takes much less time than comparable products currently on the market. Control valve installation is made easy because the distributor tube can be cut ½" above to ½" below the top of tank thread. The distributor tube is held in place by an o-ring seal and the control valve also has a bayonet lock feature for upper distributor baskets.

The AC adapter power pack comes with a 15 foot power cord and is designed for use with the control valve. The AC adapter power pack is for dry location use only. The control valve remembers all settings for up to 8 hours if the power goes out and the battery is not depleted. After 8 hours, the only item that needs to be reset is the time of day; other values are permanently stored in the nonvolatile memory. If a power loss lasts less than 8 hours and the time flashes on and off, the time of day should be reset and the non rechargeable battery should be replaced.

Table 1 shows the order of the cycles when the valve is set up as a softener. When the WS1 or WS1.25 control valve is used as a downflow softener, two backwashes always occur. When the WS1 or WS1.25 control valve is used as an upflow softener, only one backwash occurs after brining. The OEM has the option of having the regenerant refill after the rinse cycle or have the regenerant prefill before regeneration. If the OEM chooses to have the regenerant prefill before regeneration, the prefill starts two hours before the regeneration time set. During the 2-hour period in which the brine is being made, treated (softened) water is still available. For example: regeneration time = 2:00 am, prefill option selected, downflow softener. Fill occurs at 12:00 a.m., start of backwash cycle occurs at 2:00 a.m.

Table 1
Regeneration Cycles Softening

WS1 & WS1.25 Downflow Regenerant Refill After Rinse	WS1 & WS1.25 Downflow Regenerant Prefill	WS1 & WS1.25 Upflow Regenerant Refill After Rinse	WS1 & WS1.25 Upflow Regenerant Prefill
1 st Cycle: Backwash	1 st Cycle: Fill/Dissolve	1 st Cycle: Regenerate	1 st Cycle: Fill/Dissolve
2 nd Cycle: Regenerate	2 nd Cycle: Backwash	2 nd Cycle: Backwash	2 nd Cycle: Regenerate
3 rd Cycle: Backwash	3 rd Cycle: Regenerate	3 rd Cycle: Rinse	3 rd Cycle: Backwash
4 th Cycle: Rinse	4 th Cycle: Backwash	4 th Cycle: Fill/Dissolve	4 th Cycle: Rinse
5 th Cycle: Fill/Dissolve	5 th Cycle: Rinse	5 th Cycle: Service	5 th Cycle: Service
6 th Cycle: Service	6 th Cycle: Service		

¹ Noryl is a trademark of Sabic Innovative Plastics IP B.V. Company

When set up as a softener the backwash and rinse cycles automatically increase with increasing salt dosage. Backwashes can be set to be NORMAL or LONGER. The option selected will apply to all backwashes. Tables 2 and 3 show the length of the cycles when the valve is set up as a softener.

Table 2
Backwash Normal Length Softener
Cycle Times in Minutes

		WS1 & WS1.25 Downflow Softener			WS1 & WS1.25 Upflow Softener		
Grains Capacity/lb NaCl		6000 to 3501	3500 to 2501	2500 to 1700	6000 to 3501	3500 to 2501	2500 to 1700
lbs NaCl/cu ft resin ²		Less than 7.5	7.5 to 12	More than 12	Less than 7.5	7.5 to 12	More than 12
Cycle time in Minutes	Backwash Normal	6	8	8			
	Regenerate	45	60	75	45	60	75
	Backwash Normal	3	8	10	6	10	12
	Rinse	3	4	6	3	4	6
	Total ³	57	80	99	54	74	93

Table 3
Backwash Longer Length Softener
Cycle Times in Minutes

		WS1 & WS1.25 Downflow Softener			WS1 & WS1.25 Upflow Softener		
Grains Capacity/lb NaCl		6000 to 3501	3500 to 2501	2500 to 1700	6000 to 3501	3500 to 2501	2500 to 1700
lbs NaCl/cu ft resin ²		Less than 7.5	7.5 to 12	More than 12	Less than 7.5	7.5 to 12	More than 12
Cycle time in Minutes	Backwash Longer	8	10	12			
	Regenerate	45	60	75	60	70	80
	Backwash Longer	8	10	12	12	14	16
	Rinse	4	6	8	5	7	9
	Total ³	65	86	107	77	91	105

Table 4 shows the order of the cycles when the valve is set up as a filter. When the control valve is used as a downflow regenerating filter, the OEM has the option to specify one backwash or two backwashes. If the control valve is set to regenerate for a filter, the OEM has the option of having the regenerant refill after the rinse cycle or have the regenerant prefill before regeneration. If the OEM chooses to have the regenerant prefill before regeneration, the prefill starts two hours before the regeneration time set. During the 2-hour period in which the regenerant is being made, treated water is still available. For example: regeneration time = 2:00 am, prefill option selected, downflow filter. Fill occurs at 12:00 a.m., start of backwash cycle occurs at 2:00 a.m. There is only one rinse. Backwashes can be set to normal or longer. The option selected will apply to all backwashes. Tables 5 and 6 show the length of the cycles when the valve is set up as a filter.

When the control valve is used as a non-regenerating filter, the OEM has the option to specify one backwash or two backwashes. If two backwashes are specified, two rinses occur. Tables 5 and 6 show the length of the cycles when the valve is set up as a filter. When used as a non-regenerating filter, the downflow piston must be installed, the regenerant piston removed, injector plugs must be installed in both the DN and UP injector locations and the refill elbow must be replaced with a refill port plug.

² These are reference numbers that approximate the amount of salt needed. The actual capacity in grains per pound of salt is used in calculations.

³ Total time does not include fill time, which is dependent upon the amount of salt needed. When in the fill mode the system is providing treated water.

Table 4
Regeneration Cycles Filtering

WS1 & WS1.25 Downflow Regenerant Refill After Rinse	WS1 & WS1.25 Downflow Regenerant Prefill	WS1 & WS1.25 No Regeneration
1 st Cycle: Backwash 2 nd Cycle: Regenerate 3 rd Cycle: <i>Second Backwash*</i> 4 th Cycle: Rinse 5 th Cycle: Fill 6 th Cycle: Service	1 st Cycle: Fill 2 nd Cycle: Backwash 3 rd Cycle: Regenerate 4 th Cycle: <i>Second Backwash*</i> 5 th Cycle: Rinse 6 th Cycle: Service	1 st Cycle: Backwash 2 nd Cycle: Rinse 3 rd Cycle: <i>Second Backwash*</i> 4 th Cycle: <i>Second Rinse**</i> 5 th Cycle: Service

*Second backwash is optional

**Second rinse only occurs if Second Backwash option is selected.

Table 5
**Regenerating Filter
Cycle Times in Minutes**

	WS1 & WS1.25 Single Backwash		WS1 & WS1.25 Double Backwash	
	Normal	Longer	Normal	Longer
Backwash	14	16	8	12
Regenerate	60	60	60	60
2 nd Backwash			10	12
Rinse	8	10	8	10
Total ⁴	82	86	86	94

Table 6
**Non-Regenerating Filter
Cycle Times in Minutes**

	WS1 & WS1.25 Single Backwash		WS1 & WS1.25 Double Backwash	
	Normal	Longer	Normal	Longer
Backwash	14	16	8	12
Rinse	8	10	6	6
2 nd Backwash			10	12
2 nd Rinse			8	10
Total	22	26	32	40

The control valve with a water meter can be set for Demand Initiated Regeneration (DIR) only, Time Clock operation only or DIR and Time Clock which ever comes first, depending upon what settings are selected for Day Override and Gallon Capacity.⁵ See Table 7.

If a control valve does not contain a meter, the valve can only act as a time clock, and day override should be set to any number and gallon capacity should be set to off.

⁴ Total time does not include fill time, which is dependent upon the amount of fill needed. When in the fill mode the system is providing treated water.

⁵ See Installer Display Settings Step 3I, OEM Softener Setup Step 6S and OEM Filter Setup Step 5F for explanations of Day Override and Gallon Capacity.

Table 7
DIR/Time Clock Options

DIR	Time Clock	Reserve Capacity	Softener	Filter		Settings ⁶	
				Regenerant	Backwash Only	Day Override	Gallon Capacity
Yes		Automatically Calculated	Yes			Off	Auto
Yes		If desired enter a value less than estimated capacity	Yes	Yes	Yes	Off	Any Number
Yes	Yes	Automatically Calculated	Yes			Any Number	Auto
Yes	Yes	If desired enter a value less than estimated capacity	Yes	Yes	Yes	Any Number	Any Number
	Yes	None	Yes	Yes	Yes	Any Number	Off

For DIR Softeners, there are two options for setting the Gallons Capacity. The Gallons Capacity is automatically calculated if set to AUTO. Reserve Capacity is automatically estimated based on water usage if AUTO is used. The other option is to set the Gallons Capacity to a specific number. If a specific number is set, reserve capacity is zero, unless the value is manually set (i.e. the manufacturer intentionally sets the gallon capacity number below the calculated capacity of the system).

The WS1 & WS1.25 control valves can also be set to regenerate immediately or at the next regeneration time by changing the Regeneration Time Option. There are three choices for settings:

1. "NORMAL" means regeneration will occur at the preset regeneration time.
2. "on 0" means regeneration will occur when the gallons capacity reaches zero.
3. "NORMAL + on 0" means the regeneration will occur at the preset regeneration time unless the gallons capacity reaches zero. If the gallons capacity reaches zero the regeneration will begin 10 minutes after no water usage.

The user can initiate manual regeneration. The user has the option to request the manual regeneration at the delayed regeneration time or to have the regeneration occur immediately:

1. Press and release REGEN. "Regen Today" will flash on the display and the regeneration will occur at the delayed regeneration time. The user can cancel the request by pressing and releasing REGEN. This method of manually initiating regeneration is not allowed when the system is set to "on 0", i.e. to immediately regenerate when the gallon capacity reaches zero.
2. Pressing and holding REGEN for approximately 3 seconds will immediately start the regeneration. The user cannot cancel this request, except by resetting the control by pressing NEXT and REGEN simultaneously for 3 seconds.

A unique feature of this control valve is the ability to display actual water usage for the last 63 days. The values are initially stored as "----". This means the value is unknown. As days pass values are stored as "0" for no flow or the actual number of gallons. The counting of the gallons starts at the regeneration time. If no regeneration time can be set (i.e. when the valve is set for immediate regeneration) the counting of gallons starts at 12 a.m. Day 1 is yesterday, day 2 the day before yesterday, etc.

Another unique feature is that the valve automatically calculates a reserve capacity when set up as a softener with "Gallons Capacity" set to "AUTO" and the "Regeneration Time Option" set to "Normal" or "Normal + on 0". The actual reserve capacity is compared to the gallons capacity remaining immediately prior to the preset regeneration time. A regeneration will occur if the actual reserve capacity is less than the gallons capacity remaining. The actual reserve capacity is calculated by using the estimated reserve capacity and adjusting it up or down for actual usage.

The estimated reserve capacity for a given day of the week is the maximum value stored for the last three non-trivial water usages (i.e. more than 20 gallons/day) in seven day intervals.

⁶ Day Override and Gallon Capacity cannot be set to "oFF" at the same time.

OEM General Instructions

The control valve offers multiple procedures that allow the valve to be modified to suit the needs of the installation. These procedures are:

- OEM Softener Setup
- OEM Filter Setup
- Installer Displays & Settings
- User Displays & Settings
- Diagnostics
- Valve History

These procedures can be accessed in any order. Details on each of the procedures are provided on the following pages.

At the discretion of the manufacturer, the field technician can access all settings. To “lock out” access to diagnostic and valve history displays and modifications to settings except hardness, day override, time of regeneration and time of day by anyone but the manufacturer, press ▼, NEXT, ▲, and SET CLOCK in sequence after settings are made. To “unlock”, so other displays can be viewed and changes can be made, press ▼, NEXT, ▲, and SET CLOCK in sequence.

When in operation normal user displays such as time of day, gallons remaining or days remaining before regeneration are shown. When stepping through a procedure, if no buttons are pressed within five minutes the display returns to a normal user display. Any changes made prior to the five minute time out are incorporated.

To quickly exit OEM Softener Setup, OEM Filter Setup, Installer Display Settings, Diagnostics or Valve History press SET CLOCK. Any changes made prior to the exit are incorporated.

When desired all information in Diagnostics may be reset to zero when the valve is moved to a new location. To reset to zero, press NEXT and ▼ simultaneously to go to the Service/OEM 1 screen, and release. Press ▲ and ▼ simultaneously to reset diagnostic values to zero. Screen will return to User Display.

Sometimes it is desirable to have the valve initiate and complete two regenerations within 24 hours and then return to the preset regeneration procedure. It is possible to do a double regeneration if the control valve is set to “NORMAL” or “NORMAL + on 0” in Step 9S or Step 7F. To do a double regeneration:

1. Press REGEN once. REGEN TODAY will flash on the display.
2. Press and hold REGEN for three seconds until the valve regeneration initiates.

Once the valve has completed the immediate regeneration, the valve will regenerate one more time at the preset regeneration time.

OEM Softener System Setup Quick Reference

This is a quick reference setup procedure. See OEM Softener System Setup Detail for more information on available settings.

STEP 1S – Press NEXT and ▼ simultaneously for 3 seconds. If screen in step 2S does not appear in 5 seconds the lock on the valve is activated. To unlock press ▼, NEXT, ▲, and SET CLOCK in sequence, then press NEXT and ▼ simultaneously for 3 seconds.

STEP 2S – Choose Softening using ▼ or ▲. Press NEXT to go to Step 3S. Press REGEN to exit OEM Softener System Setup.

STEP 3S – Enter the ion exchange capacity in grains of hardness as calcium carbonate for the system based on test data using ▼ or ▲. Press NEXT to go to Step 4S. Press REGEN to return to previous step.

STEP 4S – Enter the pounds of salt per regeneration using ▼ or ▲. Press NEXT to go to Step 5S. Press REGEN to return to previous step.

STEP 5S – Backwash: Select “NORMAL” or “LONGER” using ▼ or ▲. See Tables 2 or 3 for backwash times. Press NEXT to go to Step 6S. Press REGEN to return to previous step.

STEP 6S – Set Gallons Capacity using ▼ or ▲:

- “AUTO” (reserve capacity automatically estimated and gallons capacity automatically calculated from grains capacity and water hardness);
- “oFF” (regeneration based on day override); or
- number of gallons (20 to 50,000).

See Setting Options Table for more detail. Press NEXT to go to Step 7S. Press REGEN to return to previous step.

STEP 7S – Set Refill option using ▼ or ▲:

- “PoST” to refill the brine tank after the final rinse; or
- “PrE” to refill the brine tank two hours before the regeneration time set.

Press NEXT to go to Step 8S. Press REGEN to return to previous step.

STEP 8S – Set regenerant downflow or upflow using ▼ or ▲:

- “dn” if the regenerant is to flow downward through the media; or
- “UP” if the regenerant is to flow upward through the media.

Prior to selecting a regenerant flow direction, verify the correct valve body, main piston, regenerant piston, and stack are being used, and that the injector or injector plug(s) are in the correct locations. See Valve Body Compliance Table in WS1 & WS1.25 Drawings and Service Manual.

Press NEXT to go to Step 9S. Press REGEN to return to previous step.

STEP 9S – Set Regeneration Time Option using ▼ or ▲:

- “NORMAL” means regeneration will occur at the preset time;
- “on 0” means regeneration will occur immediately when the gallons capacity reaches 0 (zero); or
- “NORMAL + on 0” means regeneration will occur at one of the following:
 - the preset time when the gallons capacity falls below the reserve or the specified number of days between regenerations is reached whichever comes first; or
 - after 10 minutes of no water usage when the gallon capacity reaches 0 (zero).

See Setting Options Table for more detail. Press NEXT to exit OEM Softener System Setup. Press REGEN to return to previous step.

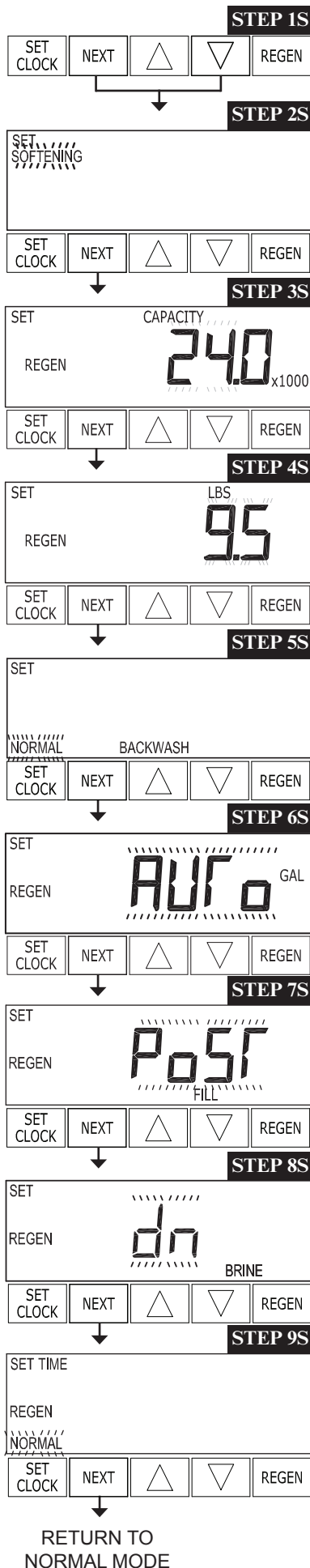

RETURN TO
NORMAL MODE

Setting Options Table

Filters should only use shaded options.

Volume Capacity	Regeneration Time Option	Day Override	Result ⁷
AUTO	NORMAL	oFF	Reserve capacity automatically estimated. Regeneration occurs when volume capacity falls below the reserve capacity at the next Regen Set Time
AUTO	NORMAL	Any number	Reserve capacity automatically estimated. Regeneration occurs at the next Regen Set Time when volume capacity falls below the reserve capacity or the specified number of days between regenerations is reached.
Any number	NORMAL	oFF	Reserve capacity <u>not</u> automatically estimated. Regeneration occurs at the next Regen Set Time when volume capacity reaches 0.
oFF	NORMAL	Any number	Reserve capacity <u>not</u> automatically estimated. Regeneration occurs at the next Regen Set Time when the specified number of days between regenerations is reached.
Any number	NORMAL	Any number	Reserve capacity <u>not</u> automatically estimated. Regeneration occurs at the next Regen Set Time when volume capacity reaches 0 or the specified number of days between regenerations is reached.
AUTO	On 0	oFF	Reserve capacity <u>not</u> automatically estimated. Regeneration occurs immediately when volume capacity reaches 0. Time of regeneration will not be allowed to be set because regeneration will always occur when volume capacity reaches 0.
Any number	On 0	oFF	Reserve capacity <u>not</u> automatically estimated. Regeneration occurs immediately when volume capacity reaches 0. Time of regeneration will not be allowed to be set because regeneration will always occur on 0.
AUTO	NORMAL + on 0	oFF	Reserve capacity automatically estimated. Regeneration occurs when volume capacity falls below the reserve capacity at the next Regen Set Time or regeneration occurs after 10 minutes of no water usage when volume capacity reaches 0.
AUTO	NORMAL + on 0	Any number	Reserve capacity automatically estimated. Regeneration occurs at the next Regen Set Time when volume capacity falls below the reserve capacity or the specified number of days between regenerations is reached or regeneration occurs after 10 minutes of no water usage when volume capacity reaches 0.
Any number	NORMAL + on 0	Any number	Reserve capacity <u>not</u> automatically estimated. Regeneration occurs at the next Regen Set Time when the specified number of days between regenerations is reached or regeneration occurs after 10 minutes of no water usage when volume capacity reaches 0.

⁷Reserve capacity estimate is based on history of water usage.

OEM Filter System Setup Quick Reference

This is a quick reference setup procedure. See OEM Filter System Setup Detail for more information on available settings.

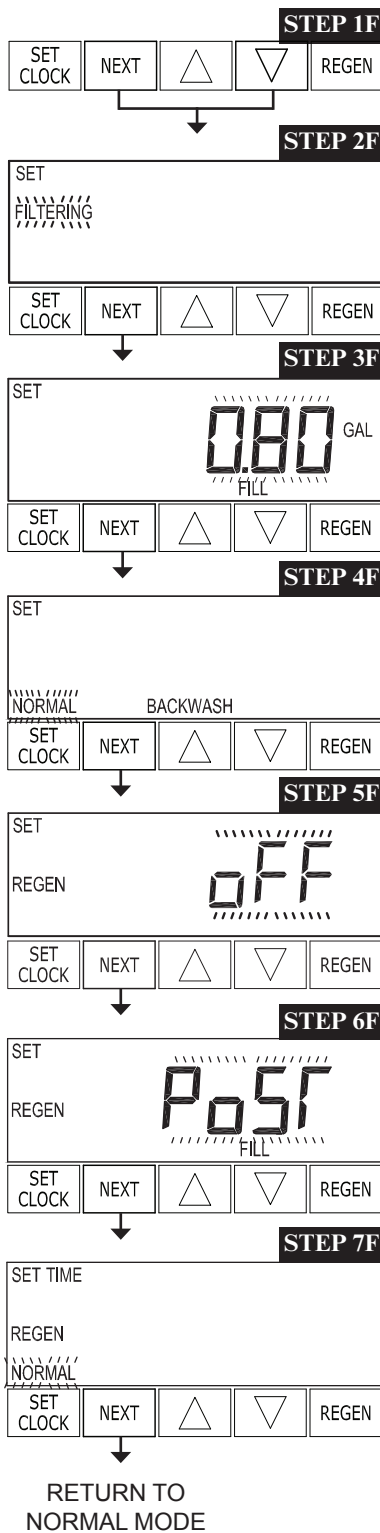

STEP 1F – Press NEXT and ▼ simultaneously for 3 seconds. If screen in step 2F does not appear in 5 seconds the lock on the valve is activated. To unlock press ▼, NEXT, ▲, and SET CLOCK in sequence, then press NEXT and ▼ simultaneously for 3 seconds.

STEP 2F – Choose Filtering using ▼ or ▲. Press NEXT to go to step 3F. Press REGEN to exit OEM Filter System Setup.

STEP 3F – Enter “oFF” if regenerant is not used (i.e. backwash only) or enter the refill volume (in gallons) using ▼ or ▲. Prior to selecting oFF or regenerant volume, verify the correct valve body, main piston, regenerant piston, and stack are being used, and that the injector or injector plug(s) are in the correct locations. See Compliance Table in Service Instructions under Injector Cap, Screen, Injector Plug and Injector section and Figure 6. Press NEXT to go to step 4F. Press REGEN to return to previous step.

STEP 4F – Backwash: Select using ▼ or ▲:

- “NORMAL” for one “NORMAL” backwash (14 minutes);
- “NORMAL 2” for two “NORMAL” backwashes (8 minutes each);
- “LONGER” for one “LONGER” backwash (16 minutes); or
- “LONGER 2” for two “LONGER” backwashes (12 minutes each).

See Tables 5 and 6 for additional details. Press NEXT to go to step 5F. Press REGEN to return to previous step.

STEP 5F – Set Gallons Capacity using ▼ or ▲:

- “oFF” (regeneration based on day override); or
- number of gallons (20 to 50,000).

See Setting Options Table for more detail. Press NEXT to go to step 6F. Press REGEN to return to previous step.

STEP 6F – Set Refill option using ▼ or ▲:

- “PoST” to refill the brine tank after the final rinse; or
- “PrE” to refill the brine tank two hours before the regeneration time set.

Press NEXT to go to step 7F. Press REGEN to return to previous step.

STEP 7F – Set Regeneration Time Option using ▼ or ▲:

- “NORMAL” means regeneration will occur at the preset time;
- “on 0” means regeneration will occur immediately when the gallons capacity reaches 0 (zero); or
- “NORMAL + on 0” means regeneration will occur at one of the following:
 - the preset time when the specified number of days between regenerations is reached; or
 - after 10 minutes of no water usage when the gallon capacity reaches 0 (zero).

This display will not appear if Step 5F is set to oFF.

See Setting Options Table for more detail. Press NEXT to exit OEM Filter System Setup. Press REGEN to return to previous step.

Installer Display Settings

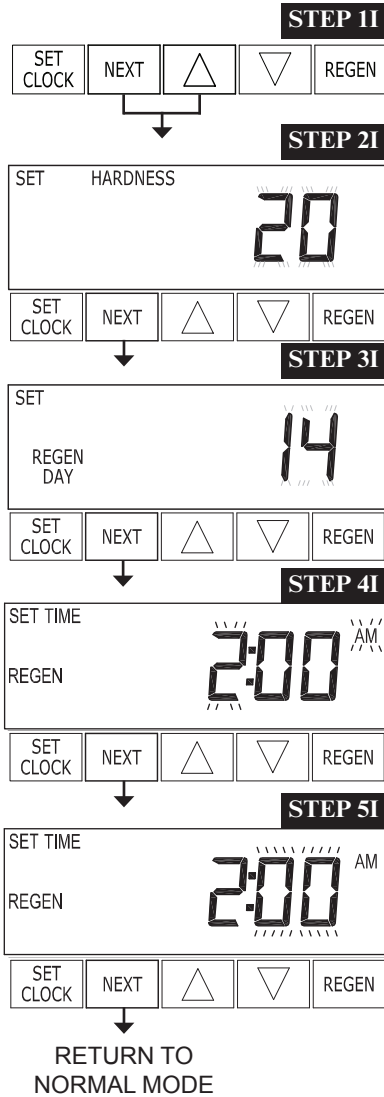

STEP 1I - Press NEXT and ▲ simultaneously for 3 seconds.

STEP 2I – Hardness: Set the amount of hardness in grains of hardness as calcium carbonate per gallon using ▼ or ▲. The default is 20 with value ranges from 1 to 150 in 1 grain increments. Note: The grains per gallon can be increased if soluble iron needs to be reduced. This display will show “–nA–” if “FILTER” is selected in Step 2F or if ‘AUTO’ is not selected in Step 6S. Press NEXT to go to step 3I. Press REGEN to exit Installer Display Settings.

STEP 3I – Day Override: When gallon capacity is set to off, Day Override sets the number of days between regenerations. When gallon capacity is set to AUTO or to a number, Day Override sets the maximum number of days between regenerations. If value set to “oFF” regeneration initiation is based solely on gallons used. If value is set as a number (allowable range from 1 to 28) a regeneration initiation will be called for on that day even if sufficient number of gallons were not used to call for a regeneration. Set Day Override using ▼ or ▲:

- number of days between regeneration (1 to 28); or
- “oFF”.

See Setting Options Table for more detail on setup. Press NEXT to go to step 4I. Press REGEN to return to previous step.

STEP 4I – Next Regeneration Time (hour): Set the hour of day for regeneration using ▼ or ▲. AM/PM toggles after 12. The default time is 2:00 a.m. This display will show “REGEN on 0 GAL” if “on 0” is selected in Step 9S or Step 7F. Press NEXT to go to step 5I. Press REGEN to return to previous step.

STEP 5I – Next Regeneration Time (minutes): Set the minutes of day for regeneration using ▼ or ▲. This display will not be shown if “on 0” is selected in Step 9S or Step 7F. Press NEXT to exit Installer Display Settings. Press REGEN to return to previous step.

To initiate a manual regeneration immediately, press and hold REGEN for three seconds. The system will begin to regenerate immediately. The control valve may be stepped through the various regeneration cycles by pressing REGEN.

User Display Settings

General Operation

When the system is operating one of two displays will be shown. Pressing NEXT will alternate between the displays. One of the displays is always the current time of day. The second display is one of the following: days remaining or gallons remaining. Days remaining is the number of days left before the system goes through a regeneration cycle. Capacity remaining is the number of gallons that will be treated before the system goes through a regeneration cycle. The user can scroll between the displays as desired.

If the system has called for a regeneration that will occur at the preset time of regeneration, the words REGEN TODAY will appear on the display.

When water is being treated (i.e. water is flowing through the system) the word “Softening” or “Filtering” flashes on the display if a water meter is installed.

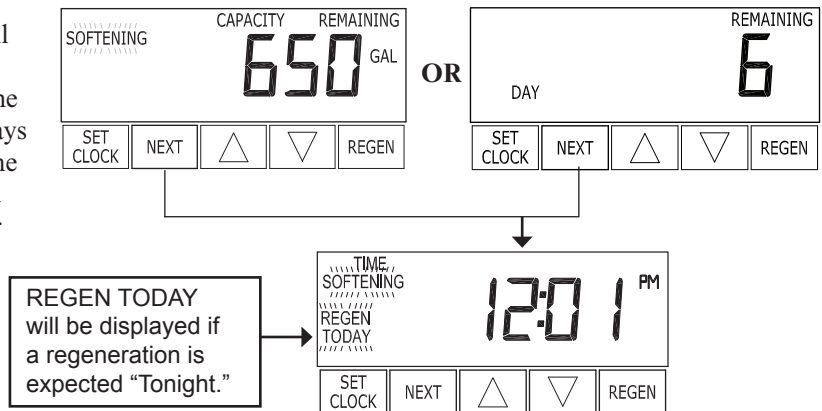

Regeneration Mode

Typically a system is set to regenerate at a time of low water usage. An example of a time with low water usage is when a household is asleep. If there is a demand for water when the system is regenerating, untreated water will be used.

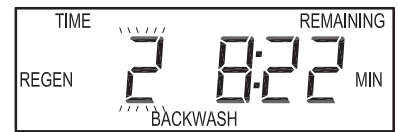

When the system begins to regenerate, the display will change to include information about the step of the regeneration process and the time remaining for that step to be completed. The system runs through the steps automatically and will reset itself to provide treated water when the regeneration has been completed.

Manual Regeneration

Sometimes there is a need to regenerate the system sooner than when the system calls for it, usually referred to as manual regeneration. There may be a period of heavy water usage because of guests or a heavy laundry day.

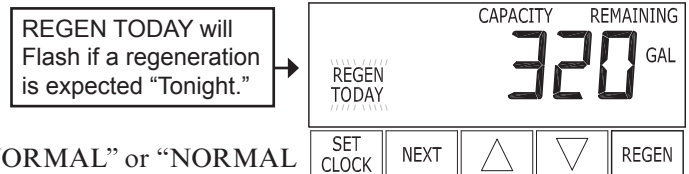

To initiate a manual regeneration at the preset delayed regeneration time, when the regeneration time option is set to “NORMAL” or “NORMAL + on 0”, press and release REGEN. The words “REGEN TODAY” will flash on the display to indicate that the system will regenerate at the preset delayed regeneration time. If you pressed REGEN in error, pressing the button again will cancel the request. Note: If the regeneration time option is set to “on 0” there is no set delayed regeneration time so “REGEN TODAY” will not activate if REGEN is pressed.

To initiate a manual regeneration immediately, press and hold REGEN for three seconds. The system will begin to regenerate immediately. The request cannot be cancelled.

Note: For softeners, if brine tank does not contain salt, fill with salt and wait at least two hours before regenerating.

Set Time of Day

The user can also set the time of day. Time of day should only need to be set after power outages lasting more than 8 hours, if the battery has been depleted and a power outage occurs, or when daylight saving time begins or ends. If a power outage lasting more than 8 hours occurs, the time of day will flash on and off which indicates the time of day should be reset. If a power outage lasts less than 8 hours and the time of day flashes on and off, the time of day should be reset and the battery replaced.

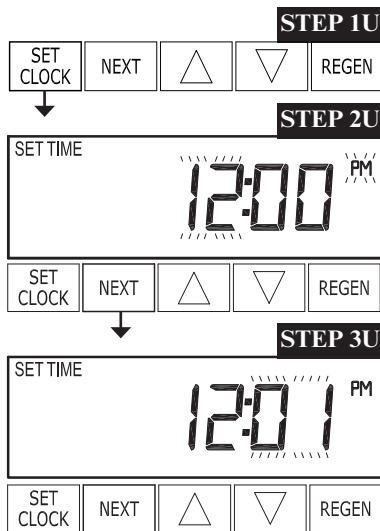

STEP 1U – Press SET CLOCK.

STEP 2U - Current Time (hour): Set the hour of the day using ▼ or ▲. AM/PM toggles after 12. Press NEXT to go to step 3U.

STEP 3U - Current Time (minutes): Set the minutes of the day using ▼ or ▲. Press NEXT to exit Set Clock. Press REGEN to return to previous step.

Power Loss

If the power goes out, the system will keep time for up to 8 hours or until the battery is depleted. If a power outage of more than 8 hours occurs, the time of day will flash on and off which indicates the time of day should be reset. The system will remember the rest. If a power outage lasts less than 8 hours and the time of day flashes on and off, the non rechargeable battery should be replaced.

Error Message

If the word “ERROR” and a number are alternately flashing on the display contact the OEM for help. This indicates that the valve was not able to function properly.

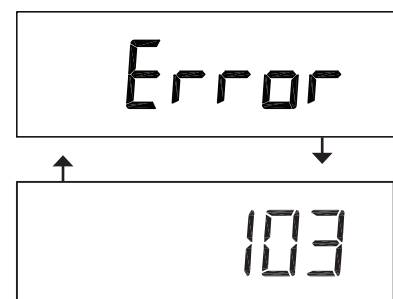

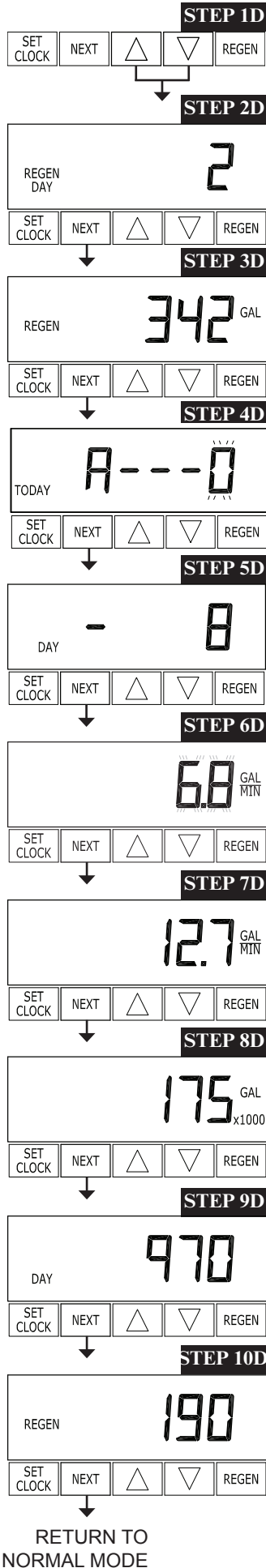

Diagnostics

STEP 1D – Press ▼ or ▲ simultaneously for three seconds. If screen in step 2D does not appear in 5 seconds the lock on the valve is activated. To unlock press ▼, NEXT, ▲, and SET CLOCK in sequence, then press NEXT and ▼ simultaneously for 3 seconds.

STEP 2D – Days, since last regeneration: This display shows the days since the last regeneration occurred. Press NEXT to go to Step 3D. Press REGEN to exit Diagnostics.

STEP 3D – Gallons, since last regeneration: This display shows the number of gallons that have been treated since the last regeneration. This display will equal zero if a water meter is not installed. Press NEXT to go to Step 4D. Press REGEN to return to previous step.

STEP 4D – Gallons, reserve capacity used for last 7 days: If the valve is set up as a softener, a meter is installed and Set Gallons Capacity is set to “Auto,” this display shows 0 day (for today) and flashes the reserve capacity. Pressing ▲ will show day 1 (which would be yesterday) and flashes the reserve capacity used. Pressing ▲ again will show day 2 (the day before yesterday) and the reserve capacity. Keep pressing ▲ to show the gallons for days 3, 4, 5 and 6. ▼ can be pressed to move backwards in the day series. Press NEXT at any time to go to Step 5D. Press REGEN to return to previous step.

STEP 5D - Gallons, 63 day usage history: This display shows day 1 (for yesterday) and flashes the number of gallons treated yesterday. Pressing ▲ will show day 2 (which would be the day before yesterday) and flashes the number of gallons treated on that day. Continue to press ▲ to show the maximum number of gallons treated for the last 63 days. This display will show dashes if a water meter is not installed. Press NEXT at any time to go to Step 6D. Press REGEN to return to previous step.

STEP 6D – Flow rate, current: The flow rate in gallons per minute will be displayed. If flow stops the value will fall to zero in a few seconds. This display will equal zero if a water meter is not installed. Press NEXT to go to Step 7D. Press REGEN to return to previous step.

STEP 7D – Flow rate, maximum last seven days: The maximum flow rate in gallons per minute that occurred in the last seven days will be displayed. This display will equal zero if a water meter is not installed. Press NEXT to go to Step 8D. Press REGEN to return to previous step.

STEP 8D – Gallons, total used since last reset: The total number of gallons used since last reset will be displayed. This display will equal zero if a water meter is not installed. Press NEXT to go to Step 9D. Press REGEN to return to previous step.

STEP 9D – Days, total number since last reset: The total number of days the control valve has been in service since last reset will be displayed. Press NEXT to go to Step 10D. Press REGEN to return to previous step.

STEP 10D – Regenerations, total number since last reset: The total number of regenerations that have occurred since last reset will be displayed. Press NEXT to exit Diagnostics. Press REGEN to return to previous step.

When desired, all information in Diagnostics may be reset to zero when the valve is installed in a new location. To reset to zero, press NEXT and ▼ simultaneously to go to the Service/OEM screen, and release. Press ▼ and ▲ simultaneously to reset diagnostic values to zero. Screen will return to user display.

Valve History

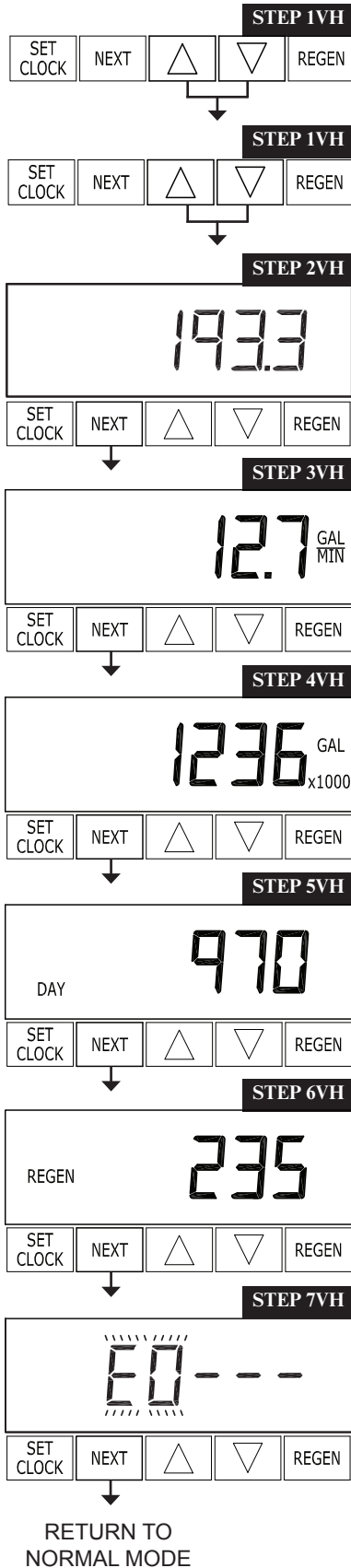

STEP 1VH – Press ▲ and ▼ simultaneously for three seconds and release. Then press ▲ and ▼ simultaneously and release. If screen in step 2VH does not appear in 5 seconds the lock on the valve is activated. To unlock press ▼, NEXT, ▲, and SET CLOCK in sequence, then press ▲ and ▼ simultaneously for 3 seconds and release. Then press ▲ and ▼ simultaneously and release.

STEP 2VH – Software Version: This display shows the software version of the valve. Press NEXT to go to Step 3VH. Press REGEN to exit Valve History.

STEP 3VH⁸ – Flow rate, maximum since startup: This display shows the maximum flow rate in gallons per minute that has occurred since startup. This display will equal zero if a water meter is not installed. Press NEXT to go to Step 4VH. Press REGEN to return to previous step.

STEP 4VH – Gallons, total used since start-up: This display shows the total gallons treated since startup. This display will equal zero if a water meter is not installed. Press NEXT to go to Step 5VH. Press REGEN to return to previous step.

STEP 5VH – Days, total since start-up: This display shows the total days since startup. Press NEXT to go to Step 6VH. Press REGEN to return to previous step.

STEP 6VH – Regenerations, total number since start-up: This display shows the total number of regenerations that have occurred since startup. Press NEXT to go to Step 7VH. Press REGEN to return to previous step.

STEP 7VH – Error Log: This display shows a history of the last 10 errors generated by the control during operation. Press ▲ or ▼ to review each error recorded. Press NEXT to exit Valve History. Press REGEN to return to previous step.

⁸ Values in steps 3VH through 7VH cannot be reset.

Front Cover and Drive Assembly

Drawing No.	Order No.	Description	Quantity
1	V3175-01	WS1 FRONT COVER ASY	1
2	V3107-01	WS1 MOTOR	1
3	V3002-A	WS1 DRIVE BRACKET ASY	1
4	V3108-10BOARD	WS1 PCB XMEGA REPL	1
5	V3110	WS1 DRIVE REDUCING GEAR 12X36	3
6	V3109	WS1 DRIVE GEAR COVER	1
7	V3106-01*	WS1 DRIVE BRACKET AND SPRING CLIP	1
Not Shown	V3186-05	WS1 POWER SUPPLY US 15VDC VI	1
	V3186EU-05	WS1 POWER SUPPLY EU 15VDC VI	
	V3186UK-05	WS1 POWER SUPPLY UK 15VDC VI	
	V3186-01	WS1 POWER CORD ONLY	

* Drawing number parts 2, 5, 6 and 7 may be purchased as a complete assembly, part V3002.

AC Adapter	U.S.	International
Supply Voltage	120V AC	230V AC
Supply Frequency	60 Hz	50 Hz
Output Voltage	15VDC	15VDC
Output Current	500 mA	500 mA

When replacing the battery, align positives and push down to fully seat.

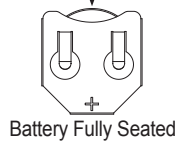

Correct Battery Orientation

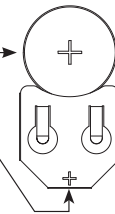

Battery replacement is 3 volt lithium coin cell type 2032.

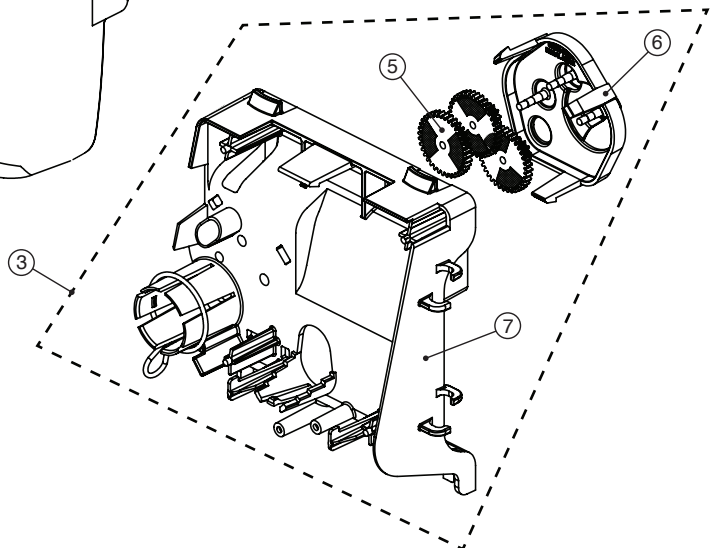
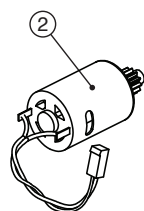
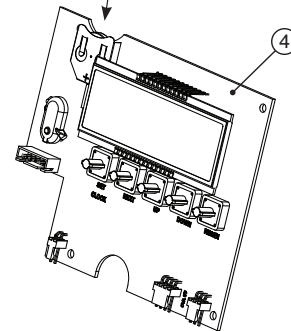
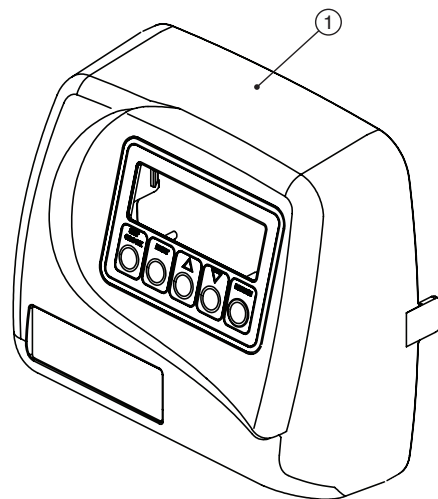

Revision History:**9/15/2015****PAGE 16:**

Drive Bracket & Spring Clip on drawing was labeled incorrectly - changed from 6 to 3.

3/4/2016**PAGE 17:**

1	V3005-02	WS1 Spacer Stack Assembly	1
---	----------	---------------------------	---

PAGE 18:

1a	V3430-01	WS1.5 Spacer Stack Assembly	1
1b	V3005-02	WS1 Spacer Stack Assembly	

6/20/2016

Removed Drive Assembly and 1 7/8" / 1.25" identification drawings - see Service Manual

7/12/2016**PAGE 8:**

Removed: The one exception is current flow rate display under the diagnostic procedure. The current flow rate display has a 30 minute time out feature.

PAGE 14:

Step 6D - Removed: Turn the water on at one or more taps in the building.

1/27/2017**PAGE 16:**

* Drawing number parts 2, 3, 5 and 6 may be purchased as a complete assembly, part V3002.

8/16/2017**PAGE 16:**

Updates to table and drawing - Bracket and Spring Clip / Power Supply